

DynaLabs

**Model SA-500
Shaker Amplifier
Product Manual**

Product Support

If at any time you have questions or problems with the SA-500 Shaker Amplifier, please contact a Dynalabs engineer at:

Phone: +90 312 386 21 89 (9 a.m. to 5 p.m., UTC +3)

e-mail: info@dynamalabs.com.tr

Warranty

Our products are warranted against defective materials and workmanship for one year. Defects arising from user errors are not covered by the warranty.

Copyright

All copyrights of this manual belonging to Dynalabs products are reserved. It cannot be reproduced without written consent.

Disclaimer

Dynalabs Ltd. provides this publication "as is" without warranty of any kind, express or implied, including but not limited to, the implied warranties of merchantability or fitness for a particular purpose. This document is subject to change without notice, and should not be construed as a commitment or representation by Dynalabs Ltd.

This publication may contain inaccuracies or typographical errors. Dynalabs Ltd. will periodically update the material for inclusion in new editions. Changes and improvements to the product described in this manual may be made at any time.

Content

- 1. General Product Description4
- 2. Product Features - Technical Data sheet.....4
- 3. Technical specification6
 - 3.1. Test conditions6
 - 3.2. Bandwidth7
 - 3.3. DC stability:7
 - 3.4. Amplifier protection systems8
 - 3.5. Mechanical dimensions.....8
 - 3.6. Storage and transport conditions according to IEC 60068-28
- 4. Commissioning9
 - 4.1. Preparation9
 - 4.2. Mains connection.....9
 - 4.3. Fuse check and replacement9
 - 4.4. Earthing10
 - 4.5. Operation10
 - 4.6. Warning signals and troubleshooting11
- 5. Description12
 - 5.1. Front view12
 - 5.1.1. Display panel.....13
 - 5.1.2. Function: Current Limiter16
 - 5.1.3. Function: Gain.....16
 - 5.1.4. Function: V/C Mode.....16
 - 5.1.5. Function: Phase17
 - 5.1.6. Function: Power.....17
 - 5.2. Rear view.....17
 - 5.2.1. INPUT Connections18
 - 5.2.2. Monitor connections19
 - 5.2.3. Mains connection19
 - 5.2.4. Connection OUTPUT20

1. General Product Description

The SA 500 DynaLabs power amplifier has been developed for the purposes of controlling vibration test machines of up to 500 VA.

The continuous sine output power is based upon a load impedance of 4 Ohm with a 500 VA. The minimum load at the output of the amplifier should not be less than 0.9 Ohm! The power amplifier has a usable frequency range of 40 Hz to 60 kHz at full power or from DC to 200 kHz at reduced power with the lowest distortion factor. The power amplifier is not short-circuit proof! Short circuits at the output of the amplifier can destroy the amplifier, even if they are only present for a short time!

The power amplifier is extremely stable and reliable when operated within the temperature and mains voltage ranges specified.

The power amplifier can operate in either current mode or voltage mode. When operating the power amplifier in current mode, you should already be aware of the special knowledge required. The maximum output current is fully adjustable.

2. Product Features - Technical Data sheet

General	
Power Output max	500 VA into a 4 Ohm resistive load
Frequency Range	DC... 60 kHz 60 kHz... 200 kHz small signal (-20 dB)
Output Voltage max	45 V RMS
Output Current max	5 A DC 9 A RMS 0,1 Hz... 20 Hz 11 A RMS 20 Hz... 20 kHz 9 A RMS 20 kHz... 40 kHz 8 A RMS 40 kHz... 60 kHz
Input Voltage	< 5 V

Input Impedance	> 10 kOhm		
Power Supply	230 V \pm 5 %, 50 Hz / 60 Hz single phase, AC mains supply, 1070 VA power consumption		
Monitor Output	Voltage Monitor	0.1 V/V \pm 3 %	0.1 Hz... 60 kHz
	Current Monitor	0.1 V/A \pm 3 %	0.1 Hz... 60 kHz
Dimensions	With	482 mm (19 in), with flanges standard 19" rack	
	Height	88 mm, corresponds to 2 HU	
	Depth	290 mm	
Weight	18 kg		
Bandwidth Voltage Mode			
Frequency Range	DC... 60 kHz		
	60 kHz... 200 kHz	small signal (-20 dB)	
Gain	Nominal	18 V/V	
	\pm 0.5 dB	0.1 Hz... 60 kHz	
	\pm 3 dB	60 kHz... 200 kHz	
Total Harmonic Distortion	< 0,05 %	40 Hz... 5 kHz	
	< 0,1 %	5 kHz... 20 kHz	
	< 0.2 %	20 kHz... 60 kHz	
	< 0.2 %	60 kHz... 200 kHz -20dB	
Signal-to-Noise Ratio	> 110 dB (full power, -0.5 dB)		
Bandwidth Current Mode			
Frequency Range	DC... 50 kHz @ 4 Ohm resistive load 50 kHz... 80 kHz @ 4 Ohm resistive load small signal (-20dB)		

Gain	Nominal	4.4 A/V
	± 0.5 dB	DC... 15 kHz @ 4 Ohm resistive load
	± 3 dB	15 kHz... 50 kHz @ 4 Ohm resistive load
Total Harmonic Distortion	< 0,2 %	40 Hz... 5 kHz
	< 0.8 %	5 kHz... 20 kHz
	< 2 %	20 kHz... 50 kHz
Signal-to-Noise Ratio	> 90 dB (full power, -0.5 dB)	

3. Technical specification

3.1. Test conditions

The following test conditions were used to achieve the measured values:

- Ambient temperature 25°C
- Supply voltage 230V +-5%
- Pure resistive load $RL = 4.0 \Omega$

Output power	500 VA
Output voltage DC up to 20 kHz	45 V
Output current RMS @ 0.1 Hz to 20 Hz	9 A
Output current RMS @ 20 Hz to 20 kHz	11 A
Output current RMS @ 20 kHz to 40 kHz	9 A
Output current RMS @ 40 kHz to 60 kHz	8 A
Output current DC	5 A
Input impedance	> 10 k $k\Omega$
Input capacitance	> 47 Pf

ATTENTION:

If the system is to be connected to vibrating systems, you must ensure that the required input power of these systems is lower than the maximum output of the device. For maximum output power sine $f = 160$ Hz, RL 4 ohm we recommend basing your calculations for continuous operation on 80% of the maximum specified output power. Sufficient ventilation must also be provided. Insufficient ventilation can result in the device automatically shutting off and, in the worst case, being damaged.

3.2. Bandwidth

Frequency range at full power	20 Hz to 60 kHz
Frequency range at full power (-20 dB)	DC to 200 kHz
THD factor @ f 40 Hz to 5 kHz, full power	< 0.05 %
THD factor @ f 5 kHz to 20 kHz, full power	< 0.1 %
THD factor @ f 20 kHz to 60 kHz, full power	< 0.2 %
THD factor @ f 60 kHz to 200 kHz, (-20 dB)	< 0.2 %
Signal to noise ratio, full power (-0,5 dB)	> 110 dB
Frequency response 20 Hz bis 60 kHz	± 0.5 dB
Frequency response 20 kHz bis 100 kHz	± 20 dB

3.3. DC stability:

Less than ± 100 mV drift from 0 V with $\pm 5\%$ fluctuations in the mains supply voltage from the output value, and at 10 °C to 40 °C (50 °F to 104 °F) fluctuations in the ambient temperature.

3.4. Amplifier protection systems

Overheating shutoff	> 90 °C
Current limiting	1 A bis 11.2 A (RMS) adjustable
Clipping	LED display (doesn't shut off)
Output signal muted	in event of a fault

3.5. Mechanical dimensions

Height	2 HE (equal to 88 mm)
Width	440 (housing), 482 mm (front panel with fasteners for 19" rack mounting)
Depth	290 mm
Weight	18 kg

3.6. Storage and transport conditions according to IEC 60068-2

Temperature	In operation: 5 bis 40 ° C (41 bis 144 ° F)
Storage	-25 to 70 ° C (-13 bis 158 °F)
Humidity	In operation: 30% to 80% Storage: Damp heat: 90% relative humidity (non-condensing at 40 °C (104 °F))
Mechanical data	when amplifier not in operation Vibration: 0.3 mm, 20 m/s ² , 10 to 500 Hz Shock: 750 m/s ² Impact: 1000 impacts at 250 m/s ²
Casing:	Protection provided by casing: IP20

4. Commissioning

4.1. Preparation

The power amplifier works at an ambient temperature of between 5 and 40 °C (41 to 104 °F). Operation at full power results in the power transistors becoming warm. It is important to maintain a free flow of cool air through the input fan on the device and through the ventilation slots on the rear of the devices.

If the amplifier overheats, then the input signal will be interrupted and the amplifier will go into reset status. The amplifier must only be used indoors and at an elevation of up to 2000 m above mean sea level.

The 500 DynaLabs power amplifier is designed to fit into a standard 19-inch cabinet. It can be used freestanding on the rubber feet, or without these feet in a 19-inch instrument cabinet.

The plug on the device serves as the mains isolation equipment. When setting up the device, it is therefore necessary to ensure that the plug is accessible.

4.2. Mains connection

The unit described here can be operated with a single-phase AC power supply of 230V \pm 5% (50 to 60 Hz). The voltage is set by the manufacturer and labelled with a sticker. If the amplifier is to be operated with a different voltage, please contact DynaLabs.

4.3. Fuse check and replacement

The main fuse is located in a fuse holder. For operation on 230VAC, a T6.30 A (slow blow) fuse is required. If the fuse needs to be replaced, contact your local service representative. Under no circumstances may fuses be replaced by persons who are not qualified to conduct maintenance on electronic devices.

If the fuse is correct, the amplifier can be connected to the main voltage supply via the power supply cable. To ensure maximum operational safety, the green/yellow protective conductor must be connected to an available earthed conductor. The use of extension cables without a protective earth conductor is prohibited for reasons of safety. We recommend that the amplifier be properly connected to a ground fault circuit interrupter.

ATTENTION:

The 500 DynaLabs 230V amplifier is factory-set to the nominal voltage of 230VAC! Before switching on for the first time, check that the correct mains voltage has been set!

4.4. Earthing

The device has been earthed in compliance with regulations and is equipped with a **ground lift**. This is earthed at just one point on the amplifier in order to keep signal noise as low as possible. Despite this, when using the amplifier as part of a measurement system with various other measurement devices, you should ensure that everything is cleanly earthed to prevent a ground loop from being created. For this reason, all measurement equipment should be earthed at just one single point.

WARNING

The output of the amplifier must not under any circumstances be connected to the earth.

4.5. Operation

1. Connect the power amplifier to the shaker using an appropriate connection cable.
2. Connect the output of a signal generator to either the **AC** or **DC** input on the rear of the amplifier.
3. Turn the **Variable Gain** (dB) anti-clockwise until it stops. (**RESET** position) When the Variable Gain (dB) knob is not set to the **RESET Position**, then you should always assume that the output from the device is live. The current and voltage values on the display are purely indicative and are not an exact measured value.
4. Move the **POWER** switch to the ON position. The status, mode and phase LEDs will light up according to their function. The Status LED lights up in red until the gain is turned out of the RESET position. When the gain is turned out of the RESET position and no fault is present, the status LED lights up in green.

5. Set the desired frequency on the signal generator. Then use the variable gain (dB) rotary knob to increase the output voltage (voltage mode) until the shaker reaches the desired vibration level. When the distortion LED lights up or the maximum deflection of the shaker is reached (armature hits the end positions of the shaker), reduce the output voltage of the generator to continue operation. For sweep operation, set the generator to the lowest frequency and carefully sweep the frequency range manually at various points before selecting automatic operation.
6. To put the amplifier into stand-by during a test, turn the Amplifier Gain (dB) to the reset position. At the end of the test, switch off the amplifier with the **POWER** switch.

4.6. Warning signals and troubleshooting

One of the **red LEDs** will illuminate if a **fault** occurs in the system. In this case the test will be automatically stopped in order to protect the amplifier and the shaker. In order to determine the reason for the shutoff, some of the possible causes are described here:

LED CURRENT

- The selected current range is too low.

LED TEMPERATURE

- The amplifier overloaded while operating in the lower frequency band
- Incorrect connection to the shaker
- Invalid temperature inside the amplifier
- Device cooling is blocked

If incorrect settings on the amplifier or incorrect connection of the shaker cause a shutoff, turn **Amplifier Gain** to the **RESET** position and make the necessary changes. Normal operation can be resumed by turning **Amplifier Gain** away from **RESET**. If the shutoff was triggered by an internal fault with the amplifier or the shaker and the fault remains after performing a **RESET** on the amplifier, then please contact your servicing agent.

DANGER

If the device is operated in a way that is not described in this manual, then the protection offered by the device may be compromised.

It is not permitted to operate this unit in explosive or easily flammable environments.

5. Description

5.1. Front view



Bild 5.1 Frontside of the SA 500 DynaLabs Amplifier

- 1) OLED Display
- 2) LED Displays
- 3) Current Limiter Potentiometer
- 4) Gain Potentiometer
- 5) V/C Mode
- 6) Phase Switch
- 7) Power Switch

5.1.1. Display panel

The OLED display shows the AC output current and voltage to one decimal place.

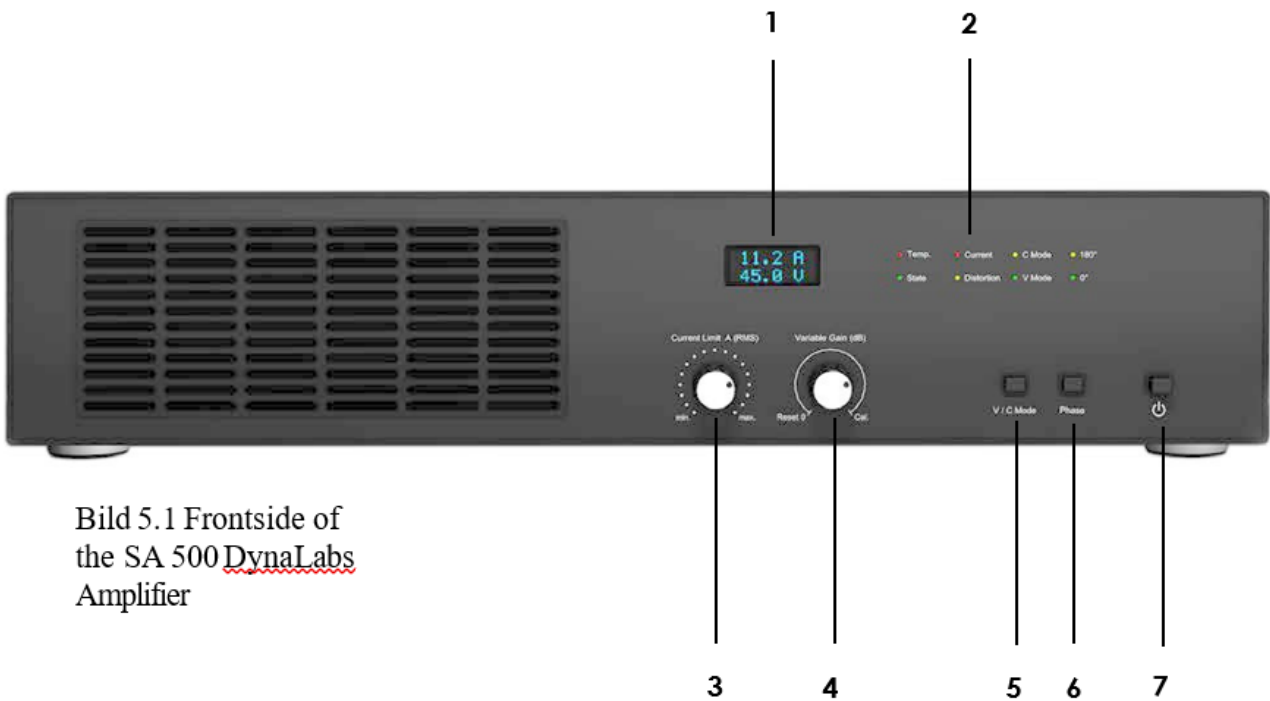
- Voltage display: RMS, read-out accuracy $\pm 5\% \pm 2$ digit, 40 Hz to 20 kHz
- Current display: RMS, read-out accuracy $\pm 5\% \pm 2$ digit, 40 Hz to 20 kHz



LED TEMPERATURE

The 'Temp' LED lights up in red when the power output transistors are **overheated**.

At the same time, the OLED display shows the text 'Reset Gain!' and 'Signal Mute!' and the 'State' LED lights up in red. The amplifier goes into standby mode and the output signal is muted. Switching RESET on the gain potentiometer clears the fault message, provided it is no longer present. The 'State' LED lights up in green after a successful RESET and the amplifier is back in operating mode.

LED CURRENT

The 'Current' LED lights up in red if the output current is too high.

At the same time, the OLED display shows the text 'Reset Gain!' and 'Signal Mute!' and the 'State' LED lights up in red. The amplifier goes into standby mode and the output signal is muted. Switching RESET on the gain potentiometer clears the fault message, provided it is no longer present. The 'State' LED lights up in green after a successful RESET and the amplifier is back in operating mode.

LED STATE

The 'State' LED lights up in red if the unit is in RESET mode or if a fault (interlock) is present. This is then additionally indicated by the corresponding fault LED.

In addition, the text 'Signal Muted!' appears on the display.

When the gain potentiometer has been turned out of the RESET state and a fault is no longer present, the 'State' LED lights up in green and indicates that the unit is ready for operation.

LED 0°

This LED illuminates green when the input and output are **in phase**.

LED 180°

This LED illuminates green when the input and output are **out of phase** by **180°**.

LED DISTORTION

The 'Distortion' LED lights up in yellow with increasing volume in the event of a disrupted output signal due to clipping or overload. The detection is based on the comparison of the DC overvoltage coming from the power supply with the maximum amplitude of the output signal. If the difference is too small for a low-distortion modulation of the power output stage, the LED starts to light up. However, the LED does not reflect a non-linear modulation based on too high a frequency of the input signal, which can also contribute to an increase in the harmonic distortion.

LED VOLTAGE MODE

This LED illuminates when the device is in voltage mode.

LED CURRENT MODE

This LED illuminates if the device is in current mode.

NOTE:

The interlock LEDs are not cleared immediately after a RESET has been triggered. Instead, the LEDs remain active for a moment to give the user the opportunity to easily recognise the interlock(s). A few seconds after a RESET, the fault LEDs are automatically cleared. If multiple faults are present, this time increases.

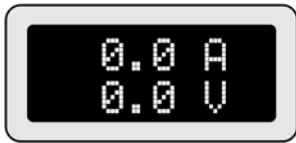

While the gain potentiometer is in the RESET state, the display will show the message 'Signal-Muted_!' alternating with '0V/0A'.

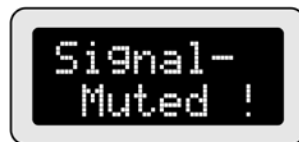
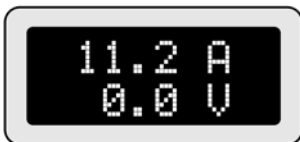

While the gain potentiometer is in the RESET state, the maximum current of the unit can be set by turning the current potentiometer. The maximum current is shown in the display. The display alternates between 'Signal Muted_!' and the configured current threshold of the maximum current. The maximum current depends on the respective unit type.

NOTE: The setting of the maximum current is only possible with units that are equipped with an ACA option (ACA - automatic current adjustment).

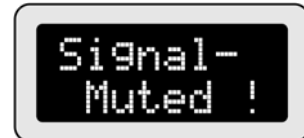
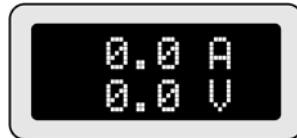

If an interlock has been triggered, the display will alternate between 'Reset-Gain!', '0V/0A' and 'Signal Muted_!' The respective fault can be read from the LEDs to the right of the OLED display. Turning the gain potentiometer to RESET mode clears the interlocks.

(Please note the information on page 22, at the top)

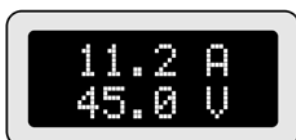

When the unit is in working mode, the output current and output voltage can be read on the display.

5.1.2. Function: Current Limiter



The “Current Limiter” Potentiometer allows an output current of between 1 and 15 A (RMS) to be set.

For units equipped with the ACA option (automatic current adjustment), the maximum output current can be set in RESET mode. The maximum current can be read on the display as long as the gain potentiometer is in the RESET state.

5.1.3. Function: Gain



This potentiometer allows the height of the **input signal** to be configured. The characteristic curve is logarithmic. In order to protect the amplifier and the connected vibration test system, the potentiometer has a reset switch. Only when the potentiometer is moved clockwise from the **RESET** position is the input signal released



5.1.4. Function: V/C Mode

This switch is used to switch between voltage and current modes. This can only be changed in RESET status.

5.1.5. Function: Phase

Pressing the switch allows the phasing between input and output to be inverted. The phasing is displayed visually.

5.1.6. Function: Power

The main switch of the amplifier can be used to switch the unit on or off. Please avoid switching the unit on and off several times in quick succession.

5.2. Rear view

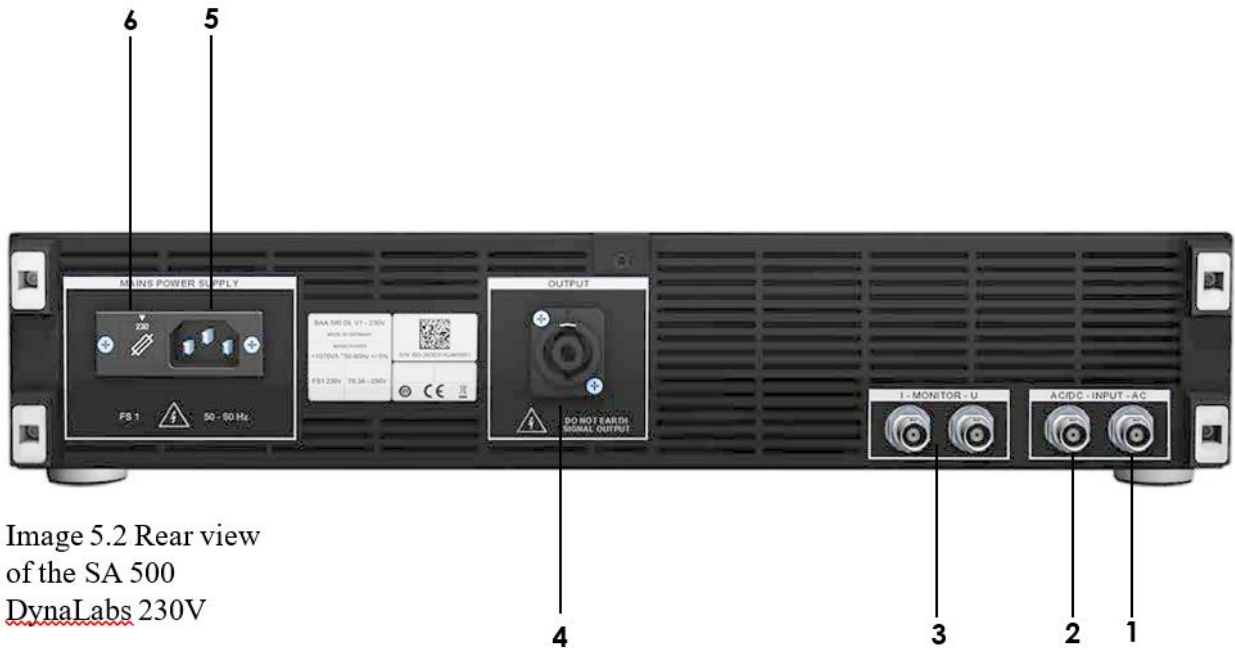
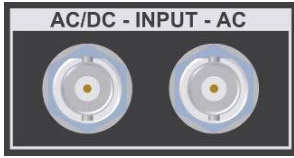

Image 5.2 Rear view of the SA 500 DynaLabs 230V

- 1 BNC connections INPUT (AC)
- 2 BNC connections INPUT (AC-DC)
- 3 Connection Monitor (U/I)
- 4 Connection OUTPUT
- 5 Power supply
- 6 Fuse Panel

5.2.1. INPUT Connections



AC/DC signal input
BNC connection with capacitively linked input to the amplifier

AC signal input
BNC connection with directly linked input to the amplifier



ATTENTION:

The signal ground (GND) must not be connected to the protective earthing (PE)!

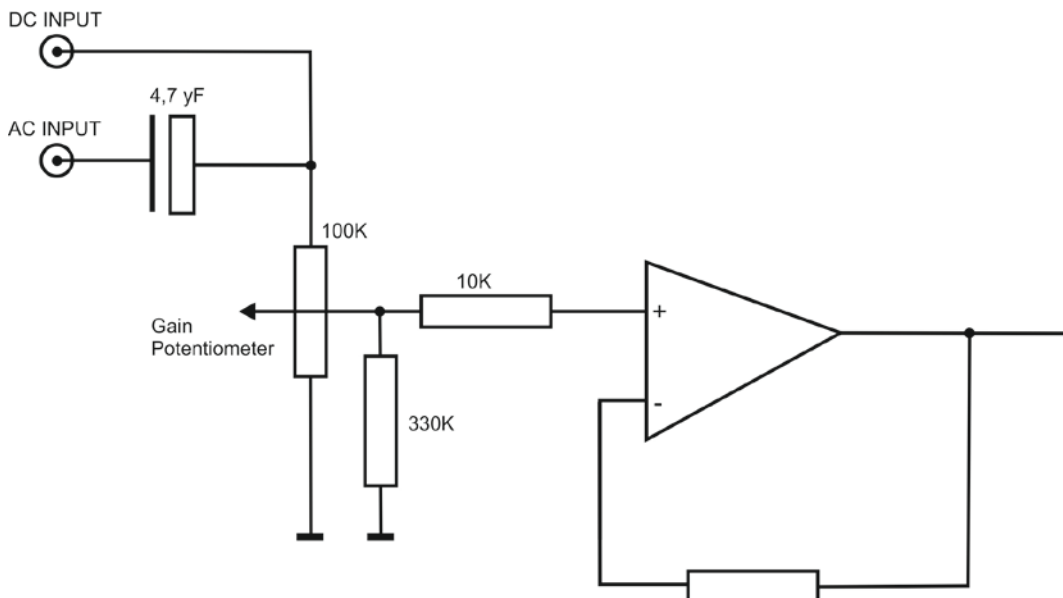

5.2.2. Monitor connections

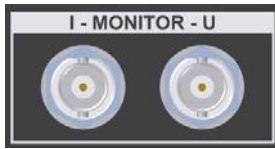

U- Monitor

This BNC output provides a signal equivalent to the **voltage output signal**. It is reduced by 20 dB and is equivalent to **0.1 V/V**

Current Monitor

This BNC output provides a signal equivalent to the **current output signal**. It is equivalent to **0.1 V/A**

5.2.3. Mains connection

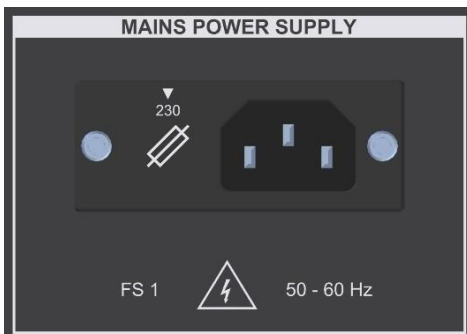

Power is supplied to the amplifier via the POWER connection socket.

FS 1: A 5x20 T6.30 A fuse (slow-blow) is recommended for operation with 230 V.

ATTENTION:

Before switching on for the first time, check that the correct mains voltage has been selected! The amplifier is factory-set to a mains AC voltage of 230V VAC.

5.2.4. Connection OUTPUT

The output port can be connected to an external load or shaker using an appropriate connection cable. At a full output power of 500 VA, the connected load should have a rated impedance of 4 ohm.

Note:

The minimum load that may be connected to the **OUTPUT** of the amplifier must always be **>0,9 ohm**

do not use a value below 0,9 ohm!

This can lead to feedback instability and possibly destroy the power amplifier.

- 1- : Signal output - (GND)
- 1+ : Signal output +
- 2- : INPUT reduced power
 Input open = IOU max. 5 A
 Input connected to GND = IOU max. 11,2 A
- 2+ : Protective earth (PE)



OUTPUT 500 VA at 4.0 Ohm
Neutrik 4 MPR plug

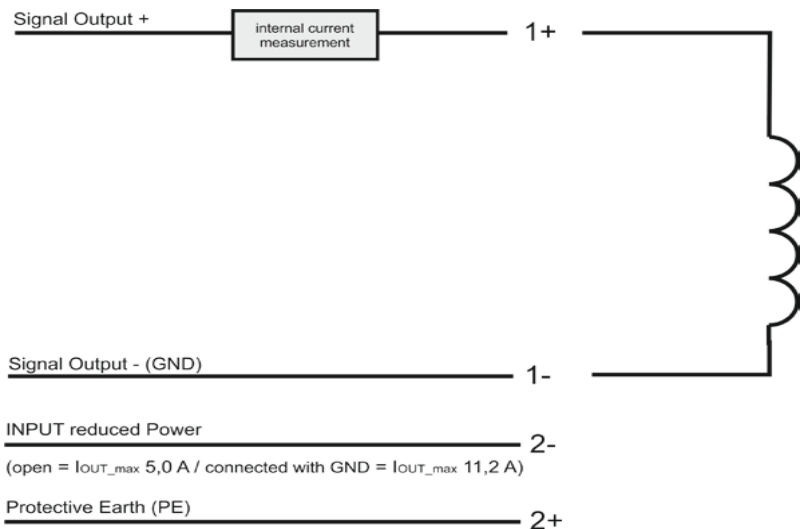

ATTENTION:

The signal output must not be connected to PE! This will result in a short circuit and irreparable damage being caused to the device.